

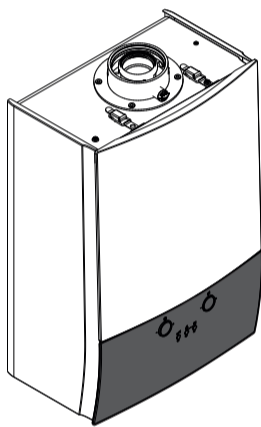

Operation manual

Wall-mounted condensing boiler



D2CND024A1AA
D2CND024A4AA

D2TND012A4AA
D2TND018A4AA
D2TND024A4AA

Operation manual
Wall-mounted condensing boiler

English

Table of Contents

Table of Contents

1	Introduction	2
1.1	About the unit	2
1.2	About the documentation	2
1.2.1	Meaning of warnings and symbols	2
2	Safety instructions	2
2.1	Installation	2
2.2	Smell of gas	3
2.3	Modifications on the unit	3
2.4	Gas conversion	3
2.5	For the user	3
3	Operation	3
3.1	User interface	3
3.1.1	Buttons and dials	4
3.1.2	LCD screen	4
3.1.3	Status indicator	4
3.2	Operating the unit	4
3.2.1	To switch ON the unit	4
3.2.2	About the low water temperature function	4
3.2.3	About the electronic gas adaptive system calibration	4
3.3	Basic usage	4
3.3.1	About the home screen	4
3.3.2	To select the operation mode	5
3.3.3	Possible operation modes	5
3.3.4	Changing temperature setpoints	5
3.3.5	Possible central heating operation modes	6
3.3.6	About the central heating ECO mode	6
3.3.7	About the domestic hot water operation	6
3.3.8	About the domestic hot water comfort mode	7
3.3.9	About the boiler frost protection	7
3.4	Error handling	7
3.5	Menu functions	7
3.5.1	To use menu level 1	7
3.5.2	Info menu	7
3.5.3	User settings menu	8
3.5.4	Installer settings menu	9
4	Maintenance and cleaning	9
4.1	To clean the outer surface of the unit	9
5	Energy saving tips	9
6	Contact	9
7	Error codes	9

1 Introduction

1.1 About the unit

This Daikin unit is a wall-mounted gas-fired condensing boiler that can supply heat to central heating systems, as well as supply domestic hot water. Depending on settings, it is possible to use the unit solely for hot water or solely for central heating. Hot water supply type can be instantaneous or by means of a hot water storage tank. The type of the boiler can be recognised from the model name written on the identification label, which is located at the right cover of the unit. See table below:

Model	Type	Domestic hot water supply	Filling loop
D2CND024A1AA	D2CND024	Instantaneous	Internal
D2CND024A4AA	D2CND024	Instantaneous	External

Model	Type	Domestic hot water supply	Filling loop
D2TND012A4AA	D2TND012	Storage tank	External
D2TND018A4AA	D2TND018	Storage tank	External
D2TND024A4AA	D2TND024	Storage tank	External





A control unit, which contains a user interface, controls the ignition, safety systems, and other actuators. User interaction is provided via that user interface, which is composed of an LCD screen, push buttons, and two dials, and which is located on the front cover of the unit.

1.2 About the documentation

The instructions contained in this document are intended to guide you through the operation of the unit. Damage caused by non-observance of these instructions are not under the responsibility of Daikin.

- The original documentation is written in English. All other languages are translations.
- The precautions described in this document are written for users and cover very important topics, follow them carefully.
- Please read the instructions in the manual carefully, for your safety and health.
- Please keep this manual for future reference throughout the unit's period of use.
- Request the installer to inform you about the settings that he made to configure your system.

1.2.1 Meaning of warnings and symbols

	DANGER Indicates a situation that results in death or serious injury.
	WARNING Indicates a situation that could result in death or serious injury.
	CAUTION Indicates a situation that could result in minor or moderate injury.
	NOTICE Indicates a situation that could result in equipment or property damage.
	INFORMATION Indicates useful tips or additional information.

2 Safety instructions

Always observe the following safety instructions and regulations.

2.1 Installation

	WARNING Installation, service, maintenance and repair of the boiler can only be carried out by suitably qualified competent persons, in accordance with the applicable legislation, regulations, rules and guidelines.
---	--

3 Operation



WARNING

The unit may only be operated with its casing properly mounted. Otherwise, in unfavourable conditions, material damage or even injury or death can result.



CAUTION

A discharge pipe must be connected to the condensate trap in order to prevent contact with the condensate.

In case your skin comes into contact with condensate, the contact location should be washed with plenty of water. Condensate liquid must never be used for purposes of cleaning, watering plants, or drinking.

2.2 Smell of gas



DANGER

This is a gas unit. Gas leaks might lead to poisoning and explosions.

If you smell gas:

- Do not use any electrical switches, including light switches.
- Do not use telephones in the affected area.
- Do not use naked flames, such as matches or lighters.
- Do not smoke.
- Turn off the main gas supply.
- Open windows and doors.
- Warn other people in the building.
- Get out of the building.
- Inform your gas supplier, service agent or other competent person.

2.3 Modifications on the unit



DANGER

Malfunctions can lead to poisoning and explosions. Never put the safety devices out of operation, nor tamper with them so as to impair their function.



CAUTION

An inappropriate modification may cause damage. Never tamper with the boiler or other parts of the system. Never attempt to perform maintenance or repair yourself. Call a qualified service agent.



CAUTION

Do not use sprays, solvents, chlorinated cleaning agents, paint, and adhesives in the vicinity of the unit. These substances can cause corrosion, even in the flue system.



DANGER

Do not damage or remove any seals on components. Only qualified persons are allowed to alter sealed components.

Do not make any modifications on:

- Boiler
- Gas, water or power supply
- Flue system

2.4 Gas conversion



WARNING

Never attempt to do gas conversion yourself. Only qualified persons can do gas conversion. Contact your service agent.

This unit is able to be operated with both natural gas and LPG. The preset gas type is indicated on the identification label of your unit. If you desire to use your unit with the other fuel type, contact your service agent.

2.5 For the user



CAUTION

Any misuse is forbidden. The manufacturer is not responsible for any malfunctions and/or damage that may occur due to misuse.

- Your unit is intended as a heater for central heating systems and for domestic hot water generation. Any other use is considered as "misuse".
- If you are not sure how to operate the unit, contact your service agent.
- This appliance can be used by children aged from 8 years and above and persons with reduced physical, sensory or mental capabilities or lack of experience and knowledge if they have been given supervision or instruction concerning use of the appliance in a safe way and understand the hazards involved. Children shall not play with the appliance. Cleaning and user maintenance shall not be made by children without supervision.



CAUTION

Do not rinse the unit. This may cause electric shocks or fire.



NOTICE

- Do not place any objects or equipment on top of the unit.
- Do not sit, climb or stand on the unit.

3 Operation

3.1 User interface

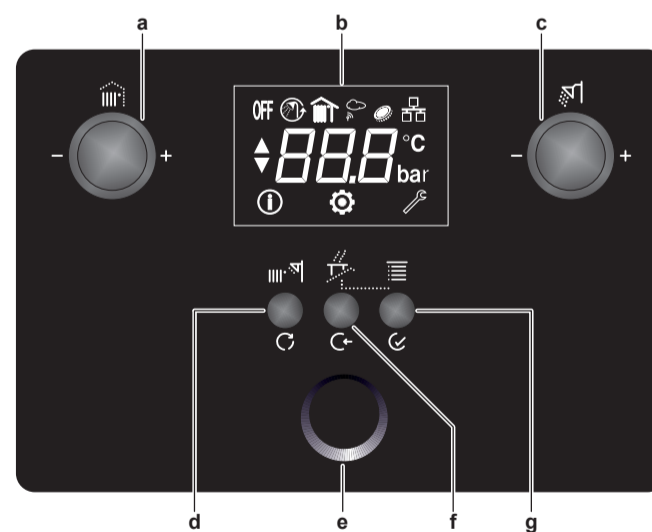

- a Left dial
- b LCD screen
- c Right dial

3 Operation

- d Mode / Reset
- e Status indicator
- f Cancel / Back
- g Menu / Enter

3.1.1 Buttons and dials

The three buttons and two dials on the user interface have various functions according to different situations, which are stated in the table below:

Button/Dial	Function	Description
Mode / Reset	Mode	Change mode between summer, winter, central heating only, standby and full-off.
	Reset	Reset the lockout error.
Cancel / Back	Cancel	Cancel changes.
	Back	Go back to the parent menu.
Menu / Enter	Menu	Enter the menu function.
	Enter	Passing on to the next level in the menu structure.
	Confirm	Confirmation of changes.
Left dial	User interaction level	Central heating temperature setpoint. This is either the central heating flow temperature, the room temperature, or the virtual room temperature, depending on the system configuration.
	Menu level	Selection of info, user, service menu.
Right dial	User interaction level	Domestic hot water temperature setpoint.
	Menu level	<ul style="list-style-type: none"> ▪ Selection parameter index. ▪ Change parameter values.

3.1.2 LCD screen

LCD screen is the monitor of the user interface. You can see the boiler operation mode, setpoints, information about actuators and menu parameters on this screen.

The LCD screen has a sleeping function. After one minute of non-interaction with the user interface, the screen darkens. Pressing any button or rotating any dial awakens the display.

When you interact with the user interface, the LCD screen will show the home screen of the active operation mode and the related setpoint, depending on the system configuration (see "3.3.3 Possible operation modes" on page 5).

Status icons

Meaning of icons that appear on the LCD screen:

Icon	Description
OFF	Operation mode: Standby mode
	Domestic hot water operation enabled
	Domestic hot water comfort mode is enabled
	Central heating operation enabled
	Room temperature
	Outdoor sensor connection
	Central heating ECO mode enabled
	Network connection
	Info menu
	User settings menu

Icon	Description
	Service settings menu

3.1.3 Status indicator

The status indicator gives first level feedback on the operation mode and status of the boiler.

Status	Description
Standby	When there is no heat demand, the status indicator shows this with a kind of breathing pulsation of the blue and white LED.
Flame	At the moment flame ignites for central heating or domestic hot water, the ring flashes to its maximum, then constantly keeps glowing during burner operation.
Error	The status indicator will go into error mode when a warning, lockout or blocking error occurs (see "3.4 Error handling" on page 7). During the error condition the status indicator continuously shows the red blinking LED.

NOTICE

In warning error, the status indicator colour turns to blue while the boiler is operating.

3.2 Operating the unit

3.2.1 To switch ON the unit

- 1 Connect the unit to the main power supply.
- 2 Press the "Mode" button for 5 seconds to switch ON the unit.
- 3 After that, you can select an operation mode by pressing the "Mode" button shortly.

Use of the unit is explained in following parts of this manual.

3.2.2 About the low water temperature function

The low water temperature function is a safety function that takes place at first central heating operation after each power supply interruption and at first central heating operation after each 90 days. When this function is active, boiler operates according to a defined set value for around 15 minutes and the icon blinks. After this function is ended, normal operation goes on.

INFORMATION

Low water temperature function is a safety function and it cannot be disabled.

3.2.3 About the electronic gas adaptive system calibration

The electronic gas adaptive system calibrates itself in pre-determined time intervals. First calibration takes place just after first burner activation after each power ON. Calibration process duration is around 60 seconds and the icon blinks. After calibration is ended, boiler modulates to required capacity. Calibration process has no effect on boiler operation.

3.3 Basic usage

3.3.1 About the home screen

It is the screen that is displayed after activating the LCD screen with one of the dials or buttons. You can use the home screen to read out settings that are meant for daily use. What you can see on the home screen depends on your system configuration.

3 Operation

The following home screens may be possible:

- Room temperature (Daikin room thermostat connected)
- Central heating set temperature
- Virtual room temperature (with outdoor sensor)
- Domestic hot water set temperature
- System pressure (at standby mode)

3.3.2 To select the operation mode

The operation mode can be changed by pressing the "Mode" button (☰).

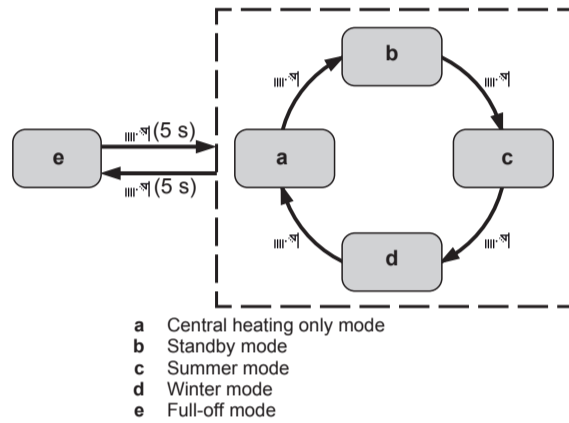

3.3.3 Possible operation modes

Operation mode	Description
<p>Central heating only mode</p>	<ul style="list-style-type: none"> • Only central heating operation mode is enabled. • The central heating temperature setpoint (which setpoint is shown depends on the system configuration; see "3.3.5 Possible central heating operation modes" on page 6) and the ☰ icon is shown on the home screen. • The ☰ icon blinks if central heating operation is active.
<p>Standby mode</p>	<ul style="list-style-type: none"> • Both central heating and domestic hot water operation modes are disabled. • The protection functions such as frost protection are still active at standby mode. • The home screen shows the system pressure, as well as the OFF icon.
<p>Summer mode</p>	<ul style="list-style-type: none"> • Only domestic hot water operation mode is enabled. Central heating operation mode is disabled. The boiler will only produce heat for domestic hot water. • The domestic hot water setpoint, and the ☰ icon is shown on the home screen. • The ☰ icon blinks if domestic hot water operation is active.

Operation mode	Description
<p>Winter mode</p>	<ul style="list-style-type: none"> • Both domestic hot water operation mode and central heating operation mode are enabled. The boiler can produce domestic hot water, as well as produce heat for central heating. • The central heating temperature setpoint (which setpoint is shown depends on the system configuration; see "3.3.5 Possible central heating operation modes" on page 6), and the ☰ icon, as well as the ☰ icon are shown on the home screen. When domestic hot water operation is active, domestic hot water setpoint is shown on the home screen. • The ☰ icon blinks if domestic hot water operation is active. • The ☰ icon blinks if central heating operation is active.
<p>Full-off mode</p>	<ul style="list-style-type: none"> • Both central heating and domestic hot water operation modes are disabled. • LCD display will be darkened and will not be activated with any user interaction. • The protection functions such as frost protection are still active at full-off mode. • Full-off mode is activated and deactivated if "Mode" button is pressed for 5 seconds while boiler is in any mode.

3.3.4 Changing temperature setpoints

Temperature setpoints can be changed with the Right/Left dials.

To change the central heating temperature setpoint

- 1 Turn the left dial while you are at the home screen. The setpoint screen will appear as shown below and the setpoint can be adjusted by turning the left dial. **Note:** The † icon means you are at the setpoint screen.

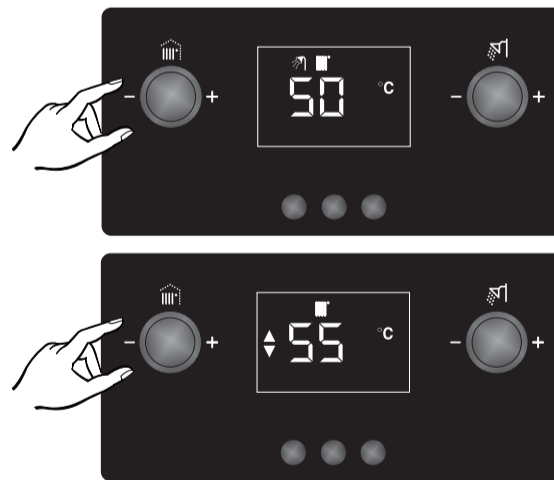

- 2 To apply changes done, wait for 3 seconds or press the "Enter" button. Pressing the "Cancel" button cancels the changes done.

3 Operation

To change the domestic hot water setpoint

- 1 Turn the right dial while you are at the home screen. The setpoint screen will appear as shown below and the setpoint can be adjusted by turning the right dial. **Note:** The  icon means you are at the setpoint screen.

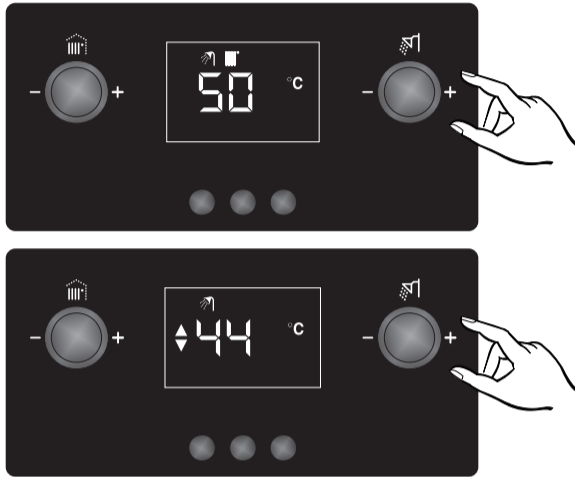





- 2 To apply changes done, wait for 3 seconds or press the "Enter" button. Pressing the "Cancel" button cancels the changes done.





NOTICE

To be able to change the setpoint of central heating or domestic hot water, the corresponding operation mode must be enabled. If it is not, the related dial has no function.

3.3.5 Possible central heating operation modes

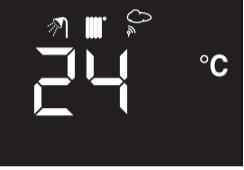
Mode	Description
Boiler only 	The case that the system only contains the boiler. No room thermostat or outdoor sensor are connected. The central heating water temperature setpoint is displayed. The setpoint can be adjusted with the left dial. The  icon is shown on the screen when the central heating operation mode is enabled.
Combination with Daikin Opentherm room thermostat (DOTT) 	The case that Daikin Opentherm room thermostat is connected to the boiler. Room temperature setpoint is displayed. The room temperature setpoint can be adjusted from the user interface by means of the left dial or from the Daikin room thermostat. The  icon is shown on the screen instead of the  icon when central heating operation mode is enabled.

Mode	Description
Boiler + outdoor sensor (Weather compensation) 	The case that outdoor sensor is connected to the boiler. In this case, the central heating water temperature is regulated according to the outdoor temperature. The virtual room temperature setpoint is displayed. The virtual room temperature setpoint can be adjusted by means of left dial. Increasing or decreasing the setpoint value reflects to the central heating water temperature and the room temperature, respectively. The  and  icons are shown on the screen when central heating operation mode is enabled.



NOTICE

To enable weather compensation, the heating slope value must be higher than "5" (see ["User settings menu: Parameters \(short\)" on page 8](#)).



INFORMATION

If an outdoor sensor is connected to the boiler together with an Opentherm room thermostat (whether DOTT or not), the rules of the case "Combination with Opentherm room thermostat" are applicable. The outdoor sensor only provides outdoor temperature data to the room thermostat for water temperature calculation.

3.3.6 About the central heating ECO mode

The central heating ECO mode provides more economic central heating. Main purpose of the ECO mode is to operate the boiler at the condensing temperature range so to increase the efficiency. ECO mode can be activated at any central heating operation mode explained above.

ECO mode can be enabled from the user settings menu (see ["User settings menu: Parameters \(short\)" on page 8](#)).



INFORMATION

ECO mode is only for central heating, it has no effect to domestic water heating.

When central heating ECO mode is enabled,  icon is shown on the screen while the central heating operation mode is enabled.

3.3.7 About the domestic hot water operation

This unit supplies domestic hot water by way of a plate heat exchanger (instantaneous) or by way of a hot water storage tank according to model of the boiler.

If the boiler is instantaneous type, domestic hot water operation is activated when water is being tapped. Water flow rate must be at least 2.5 l/min.

If it is storage tank type, domestic hot water operation is activated according to storage tank temperature value.

The  icon blinks when domestic hot water operation is active.



INFORMATION

Domestic hot water operation mode must be enabled for the boiler to be able to produce domestic hot water. (i.e. summer mode or winter mode).

3 Operation

3.3.8 About the domestic hot water comfort mode

The domestic hot water comfort mode includes a domestic hot water pre-heat function and a domestic hot water post-heat function. When the comfort mode is enabled, both pre-heat and post-heat functions are enabled.

The pre-heat function is a self-learning algorithm according to which the boiler will heat up the domestic hot water, before the tapping demand. The algorithm is based on your personal use pattern of the last 24 hours.

Note: Independent of personal use pattern, comfort mode preheating function could be adjusted to operate continuously from the user settings.

The post-heat function heats up the domestic hot water heat exchanger after tapping, when the flow temperature of the boiler is below the domestic hot water temperature setpoint.

Comfort mode can be enabled from the user settings menu (see "User settings menu: Parameters (short)" on page 8).

i INFORMATION

Domestic hot water comfort mode is only valid for instantaneous type hot water supply types.

When the domestic hot water comfort mode is enabled, the  icon is shown on the screen.

The  icon blinks when the burner is on for comfort mode.

3.3.9 About the boiler frost protection

Frost protection safety system: This function protects the unit and heating installation from frost damages. This protection activates the boiler pump when the water temperature drops below 13°C and it activates the burner when the water temperature drops below 8°C (factory setting). The unit keeps running until the temperature reaches 30°C. To enable this function, the unit must be connected to the power supply and its main gas valve must be open. Any damage caused by frost is not covered by the warranty. Frost Protection is enabled in all modes, including standby mode and full-off mode.

! WARNING

If the boiler is not connected to the power supply, frost protection is not active. Consequently, the water may freeze and cause cracks. The manufacturer is not responsible for any damage that may occur this way.

! NOTICE

When not using the boiler, we strongly recommend not to cut off the electric supply to the boiler.

3.4 Error handling

When an error occurs, the normal behaviour of the user interface is interrupted, and the status of the status indicator is affected. However, be aware that not all errors have the same effect on the user interface and the status indicator.

Error type	Boiler operation	User interface and status indicator
Warning	Continue	The status indicator does not enter error mode if the burner is on. It turns to red when the burner is off. The LCD screen stays active and displays the error code.
Blocking	Blocked, turns back to operation if cause disappears	The status indicator enters error mode. The LCD screen stays active and displays the error code.

Error type	Boiler operation	User interface and status indicator
Lockout	Blocked and a reset is required	The status indicator enters error mode. The LCD screen stays active and displays the error code. Also, the  icon starts blinking, indicating that a reset is required.

In case of a warning or a blocking error, the user interface will leave error mode and return to the home screen when the cause of the error disappears.

In case of a lockout error, the boiler needs to be reset. Press the "Reset" button to remove the error, if the cause of the error is gone. If the cause of the error is still there, the user interface will enter error mode again. When the error is solved, the user interface returns to the home screen.

If you turn any dial or press any button (except the "Reset" button) during an error, the user interface will display the home screen. After the timeout without any interaction, instead of darkening, the user interface will enter error mode.

! NOTICE

A table with all error codes, the reasons for their appearance, and possible solutions, is located at the very end of this manual.

3.5 Menu functions

3.5.1 To use menu level 1

- 1 Press the "Menu" button while you are at home screen to go the Menu screen. This is menu level 1 screen.
- 2 To switch between info, user settings and service settings, turn the left dial.
- 3 To leave the menu and return to the home screen, press "Back" for 2 seconds.

When there is no user interaction for one minute, the user interface will leave the menu and switch to the blank screen.

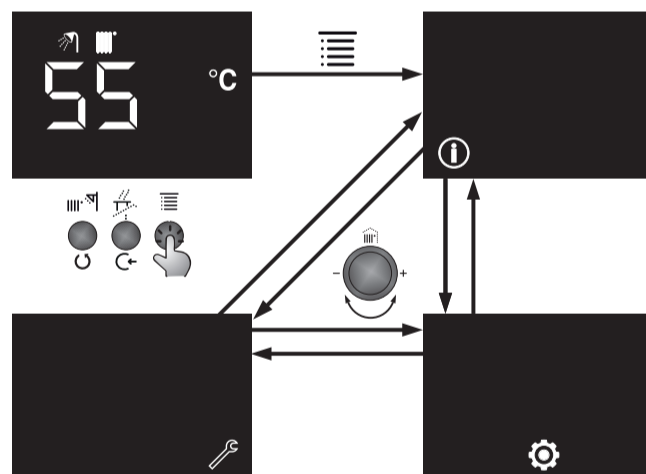

3.5.2 Info menu

Info menu: Parameters

The info menu () covers all possible information that is made available to the end user and to the installer. These parameters are read only and cannot be changed.

#	Description (short)	Unit
A00	Actual flow temperature	°C
A01	Actual return temperature	°C

3 Operation

#	Description (short)	Unit
A02	Actual domestic hot water temperature	°C
A03	Actual flue temperature	°C
A04 ^(a)	Actual outdoor temperature (if outdoor sensor is connected, otherwise "--")	°C
A05 ^(a)	Actual solar temperature (if solar sensor is connected, otherwise "--")	°C
A06	Actual water pressure	bar
A07	Actual domestic hot water flow rate	l/min
A08 ^(b)	Current set point of burner capacity	%
A09 ^(b)	Actual capacity of boiler in relation to nominal capacity	%
A10 ^(c)	Actual phase of the burner	—
A11	Status of On-Off room thermostat, indicate heat demand (HC1)	—
A12	Actual error code of boiler	—
A13	Actual fan speed (rpm/100)	rpm
A14	Current setpoint of boiler pump	%

- (a) Not applicable if the sensor is not connected.
 (b) Maximum value for central heating = 91%
 Maximum value for domestic hot water = 100%
 A10=0: Standby mode, burner is not active
 A10=1: Start-up, preparation to ignition
 A10=2: Ignition and flame stabilisation phase
 A10=3: Release control (burner is on, operation phase)
 A10=4: Post-purge phase

To use the info menu

- 1 Press the "Enter" button when the ⓘ icon is displayed on the menu level 1 screen.
- 2 Select an index between 00 and 14 with the right dial. Press the "Back" button to return to menu level 1 screen.

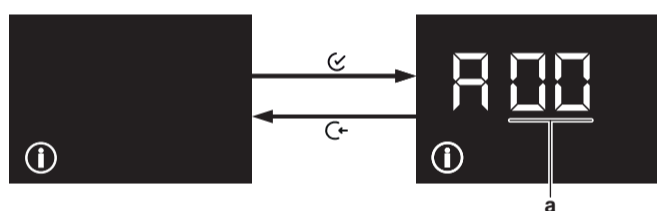

a Index

3.5.3 User settings menu

User settings menu: Parameters (short)

The user settings menu ⓘ comprises parameters that can be changed and adjusted by users. You can read out and adjust the parameters according to your preferences.

! NOTICE

If you are not sure about the function of the parameter, do not change it. Contact your service agent.

#	Description	Unit	Default	Range
U00	Summer-winter switch over temperature	°C	20	10~30
U01	Heating slope	—	0	0~40
U02	Central heating ECO mode	—	0	0~1
U03	Domestic hot water comfort mode	—	0	0~1
U04	Domestic hot water set value	°C	50	35~60
U05	Set value for the room thermostat at day mode	°C	21	10~30
U06	Set value for the room thermostat at reduced mode	°C	18	10~30

#	Description	Unit	Default	Range
U07	Set value for the flow temperature at day mode	°C	50	35~80
U08	Set value for the flow temperature at reduced mode	°C	35	35~80
U09	Domestic hot water comfort mode user record dependency	—	1	1, 2 or 24
U10	Room temperature setpoint used by Daikin Opentherm room thermostat during night	°C	18	10~30

User settings menu: Parameters (detailed)

#	Description
U00	When using outdoor sensor, above this parameter value of outside temperature, the boiler senses the season as summer and does not activate central heating although there is demand. Summer-winter switching has a hysteresis of ±1°C. i.e: When this parameter is adjusted to 20°C, the boiler switches to summer mode at 21°C and switches back to winter mode at 19°C.
U01	This value is used when only outside sensor is connected to the boiler (No Opentherm room thermostat connection). The parameter heating slope is important to adapt the weather compensation to the individual heating system, the building and the thermal insulation. The heating slope can be adjusted from 0 to 40. The heating slope needs to be increased to increase the boiler central heating set temperature. Colder regions require a higher heating slope value. Note: To activate weather compensation, the heating slope value must be higher than "5".
U02	Enabling / disabling central heating ECO mode. 1 = enabled, 0 = disabled
U03	Enabling / disabling domestic hot water comfort mode. 1 = enabled, 0 = disabled
U04	Domestic hot water set value (Same function that can be done via the right dial when domestic hot water mode is enabled).
U05	When On-Off room thermostat and outdoor sensor are both connected, this parameter value is the virtual room temperature setpoint when there is a heat demand.
U06	When On-Off room thermostat and outdoor sensor are both connected, this parameter value is the virtual room temperature setpoint when there is no heat demand. Note: For this parameter value to be active, reducing mode has to be enabled by your service agent, otherwise central heating mode will not be activated when there is no heat demand.
U07	When On-Off room thermostat is connected and outdoor sensor is not connected, this parameter value is the central heating water temperature setpoint when there is a heat demand.
U08	When On-Off Room thermostat is connected and outdoor sensor is not connected, this parameter value is the central heating water temperature setpoint when there is not a heat demand. Note: For this parameter value to be active, reducing mode has to be enabled by your service agent, otherwise central heating mode will not be activated when there is no heat demand.

4 Maintenance and cleaning

#	Description
U09	<p>If parameter is 1, comfort mode preheating will depend on the user record. It will preheat the water according to the previous day user records.</p> <p>If parameter is 2, comfort mode preheating will be independent of the user record, and at the highest comfort level (3-star comfort according to EN 13302).</p> <p>If parameter is 24, comfort mode preheating will be independent of the user record.</p> <p>Note: If you increase the comfort level, the energy consumption increases.</p>
U10	Room temperature setpoint used by Daikin Opentherm room thermostat during night mode. Only visible in case Daikin Opentherm room thermostat is connected.

To use the user settings menu

- Press the "Enter" button when the  icon is displayed on the menu level 1 screen.
Result: You can see the parameter values on menu level 2.
- Select an index between "00" and "10" with the right dial.
- Press the "Enter" button when the parameter that you want to change is displayed.
Result: You can see the menu level 3 screen. Up and down arrows will appear.
- Change the parameter with the right dial.
- Press the "Enter" button to confirm or the "Cancel" button to cancel. You will return to menu level 2 after pressing "Enter" or "Back"

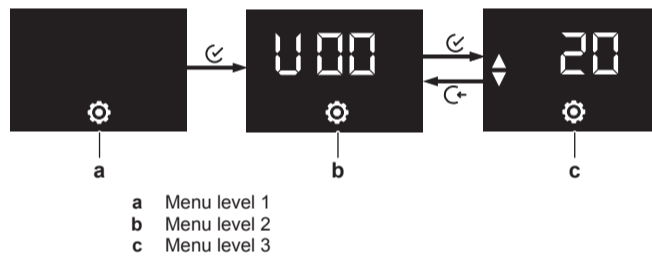

3.5.4 Installer settings menu

Only qualified persons are allowed to enter the installer settings menu.

4 Maintenance and cleaning



WARNING

The boiler should be maintained by authorised persons every year.

Annual maintenance cycle is very important for safe operation of your boiler and to ensure reliable, efficient and long lasting operation of it.

Contact your service agent for details.



DANGER

Incorrect maintenance and repairs can lead to injury and material damage.

- Never attempt to perform maintenance work or repairs on the unit yourself.
- Contact your service agent.

4.1 To clean the outer surface of the unit

Clean the outer surface of your boiler with a damp cloth and a little solvent-free soap.



CAUTION

Sprays, solvents or cleaning agents containing chlorine can damage the exterior, the fittings or the control unit. Do not use them for cleaning purposes.

5 Energy saving tips

- Operating the unit in central heating ECO mode provides the most economical central heating operation conditions.
- Do not run the boiler in domestic hot water comfort mode. Domestic hot water comfort mode involves pre- and post-heating, which is luxury, not necessity.
- Close the thermostatic radiator valves when ventilating the rooms.
- The largest heat loss occurs through windows and outer doors. Check windows and doors for air-tightness. Close any blinds at night.
- Do not hide radiators behind large furniture (i.e. couch, desk, etc.). Minimum 50 cm of clearance must remain, otherwise the heated air cannot be circulated and the room will not heat up efficiently.
- Do not let your room become too hot. Decreasing the room temperature during the day saves energy.
- Have your combi boiler's maintenance performed at least annually.
- Provide your building with sufficient heat insulation.
- Thermostatic valves should be used. Each room should be adjusted according to comfort conditions. For reception rooms, this is 20°C, living rooms 22°C, kitchens 18°C and bedrooms 18°C.
- Prevent radiators from getting covered by curtains.

6 Contact

Contact a local competent service agent if you have any questions regarding the maintenance and repair of your system. You can find the contact information of our competent services at www.daikin.com

7 Error codes

#	Problem	Solution
10-64	Gas valve circuit error	Perform reset. If problem repeats, contact your service agent.
10-65	Gas valve current error	Perform reset. If problem repeats, contact your service agent.
11-64	Ignition does not take place	Make sure valve on the gas line is opened. Perform reset after third unsuccessful ignition trial.
11-65	Flame stabilisation fault	Wait for boiler's ignition trial.
11-66	Flame signal loss in safety time	Perform reset after third unsuccessful ignition trial. If problem repeats, contact your service agent.
11-67	Flame loss during operation	Temporary error. Wait for boiler to re-ignite.
12-64	Ion control deviation is too big	Perform reset if needed. If problem repeats, contact your service agent.

7 Error codes

#	Problem	Solution
12-65	Ignition SCOT actuators fault does not take place	Perform reset if needed. If problem repeats, contact your service agent.
12-66	Ion base value exceeds lower factory limit	Perform reset. If problem repeats, contact your service agent.
12-67	Ion base value exceeds upper factory limit	Perform reset. If problem repeats, contact your service agent.
12-68	Ion base value differs excessively from previous value	Perform reset if needed. If problem repeats, contact your service agent.
12-69	Offset adaption at limit	Boiler continues operation but contact your service agent.
12-70	Offset adaption not executable	Boiler continues operation but contact your service agent.
13-64	Fan speed error	Perform reset if needed. If problem repeats, contact your service agent.
13-65	Fan speed error	Perform reset. If problem repeats, contact your service agent.
16-64	Flue temperature signalise overheating	Check flue gas discharge path. Perform reset if needed. If problem repeats, contact your service agent.
1J-64	High limit thermostat signalise overheating	<ul style="list-style-type: none"> Check the valves of the radiators in the heating circuit. Check the combi boiler water pressure. If it is low, fill the heating circuit with water. Perform reset. If problem repeats, contact your service agent.
80-01	Return temperature sensor fault	Perform reset. If problem repeats, contact your service agent.
81-01	Flow temperature sensor fault	Perform reset. If problem repeats, contact your service agent.
81-65	Domestic hot water solar temperature sensor fault	Boiler continues operation but solar sensor is defective. Contact your service agent.
8A-46	Freeze protection	Unit does not operate if flow temperature sensor reads value less than 1°C. Wait until the error code is removed from the screen.
8H-64	Flow temperature steep rise	Make sure radiator valves are open enough to circulate water. Your boiler will operate again after a while. If problem repeats, contact your service agent.
8H-65	Flow-return temperature difference too much	Make sure radiator valves are open enough to circulate water. If problem repeats, contact your service agent.
E1-64	Flame detection before burner operation	Perform reset. If problem repeats, contact your service agent.
E1-65	Internal SCOT system error	Perform reset if needed. If problem repeats, contact your service agent.
E1-66	Calibration conditions fault	No reset needed. Wait burner to restart. If problem repeats, contact your service agent.
E1-67	Missing calibration	Perform reset. If problem repeats, contact your service agent.
E1-68	Ion base value is outside the factory limits or saved incorrectly	Perform reset. If problem repeats, contact your service agent.

#	Problem	Solution
E1-69	Parameter CRC error	Perform reset. If problem repeats, contact your service agent.
E1-70	Parameter CRC error	Perform reset. If problem repeats, contact your service agent.
E1-71	EK lockout failure	Permanent error. Contact your service agent.
E1-72	SCOT flame amplifier	Perform reset if needed. If problem repeats, contact your service agent.
E1-73	Internal PCB error	Perform reset if needed. If problem repeats, contact your service agent.
H9-01	Outside sensor fault	Boiler continues operation but outside sensor is defective. Contact your service agent.
HC-01	Domestic hot water temperature sensor fault	Boiler continues operation but you must contact your service agent.
HJ-08	High system pressure	Discharge water down to 0.8 bar. (You can bleed the radiators.)
HJ-09	Low system pressure	Increase the system pressure to 0.8 bar
HJ-10	Water pressure sensor fault	Contact your service agent.
J6-01	Flow temperature sensor overheating (Can be a blocking error or a lockout error)	<ul style="list-style-type: none"> Check the valves of the radiators in the heating circuit. Check the combi boiler water pressure. If it is low, fill the heating circuit with water. Perform reset if needed. If problem repeats, contact your service agent.
J6-20	Return temperature sensor overheating (Can be a blocking error or a lockout error)	Perform reset if needed. If problem repeats, contact your service agent.
J6-21	Return temperature is higher than flow temperature	No reset needed, burner operates itself after a small amount of time. If problem repeats, contact your service agent.
JJ-64	Flue temperature sensor fault	Perform reset. If problem repeats, contact your service agent.
U2-01	Supply voltage is below low limit	Contact your service agent.
U2-01	Supply voltage is above high limit	Your boiler will continue operation but you must contact your service agent.
U4-65	Opentherm room thermostat connection is defective	Your boiler will continue operation but Opentherm room thermostat is out of operation. Contact your service agent.
U4-66	CAN-bus timeout	If problem repeats, contact your service agent.
U4-67	Remote reset supervision	Switch off - switch on power mains. If problem repeats, contact your service agent.
UA-64	Blocking during BCC update process	Contact your service agent.
UA-65	PCB requires a BCC update	Contact your service agent.
UA-66	BCC-ID of internal EEPROM is inconsistent	Contact your service agent.
UA-67	BCC is missing	Contact your service agent.

7 Error codes

#	Problem	Solution
UA-68	BCC is not compatible with PCB (BCC-ID)	Contact your service agent.
UA-69	BCC is not compatible with PCB (firmware)	Contact your service agent.
UA-70	BCC update error	Contact your service agent.

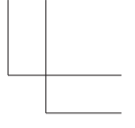
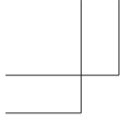

DAIKIN ISITMA VE SOĞUTMA SİSTEMLERİ SAN.TİC. A.Ş.

Küçükbakkalköy Mah. Kayışdağı Cad. No: 1 Kat: 21-22 34750 Ataşehir
İSTANBUL / TÜRKİYE
Tel: 0216 453 27 00
Faks: 0216 671 06 00
Çağrı Merkezi: 444 999 0
Web: www.daikin.com.tr

DAIKIN EUROPE N.V.

Zandvoordestraat 300, B-8400 Oostende, Belgium

3P469438-3D 2017.07

Copyright 2017 Daikin

